

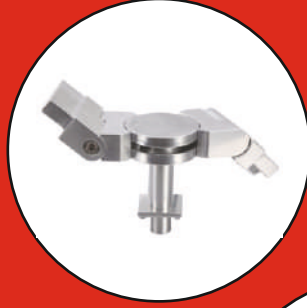

ALUMINSAN

ALUMINIUM & ACCESSORIES



PRODUCT CATALOGUE
ÜRÜN KATALOĐU



• 1001
Aldoks Düz Mentеше
Aldoks Straight Hinge



• 1003
Aldoks Fugalı Mentеше
Fuga Aldoks Hinge



• 1004
Aldoks Üstten Basmalı Mentеше
Push the hinge from the top Aldoks



• 1005
Aldoks Geçme Mentеше 6 cm
Passing Aldoks Hinge 6 cm



• 1006
Aldoks Geçme Mentеше 10 cm
Passing Aldoks Hinge 10 cm



• 1007
Aldoks Baba Mentеше
Father Aldoks Hinge



• 1008
Aldoks Üçgen Pivot Mentеше
Pivot Hinge Triangle Aldoks



• 1009
Burak ısı Yalıtım Üçgen Pivot Mentеше
Burak Heat Insulation Pivot Hinge Triangle



• 1010
Isı Yalıtım Üçgen Pivot Mentеше (Fitilli)
Heat Insulation Pivot Hinge Triangle



• 1011
Isı Yalıtım Üçgen Pivot Mentеше
Heat Insulation Pivot Hinge Triangle



• 1012
Isı Yalıtım Mentеше
Heat Insulation Hinge



• 1013
Alutec Mentеше (Sistem Alü. Profiline Uygun)
Alutec Hinges (System Alum. compatible)



• 1014
Isı Yalıtım İzo Mentеше
Heat Insulation Hinge



• 1015
Saray Isı Yalıtım Mentеше
Palace Heat Insulation Hinge



• 1016
Kurtuğlu Kapı Mentеше



• 1017
Kurtuğlu Pencere Mentеше



• 1021
C-60 Mentеше (Oval)
C - 60 Hinge Oval



• 1022
C-60 Mentеше (Köşeli)
C - 60 Hinge cornered



• 1023
C-60 Mentеше Aldoks Modeli
C - 60 Hinge Aldoks



• 1024
C-60 Mentеше Geçme Modeli
C - 60 Hinge Passing

• 1025



• 1026



• 1025 C-60 3'lü Mentese (Köşeli)
60 Triple Hinge angular

• 1026 C-60 3'lü Mentese (Oval)
C - 60 Triple Hinge Oval



• 1027
Burak Kapı Mentese
Burak Door Hinge



• 1028
Burak Pencere Mentese
Burak Window Hinge



• 1031
Yunan Mentese
Greek Hinge



• 1032
Yunan Mentese Üçlü
Greek Triple Hinge



• 1041
Beysan - Alterna Mentese
Beysan - Alterna Hinge



• 1051
Feniş 47'lik Mentese
Feniş 47 Hinge



• 1060
Yaprak Mentese
Leaf Hinge



• 1061
Panjur Mentese
Shutter Hinges



• 1071-a 33'lük Çarpma Mentese (Alüminyum)
• 1071-b 36'lük Çarpma Mentese (Alüminyum)

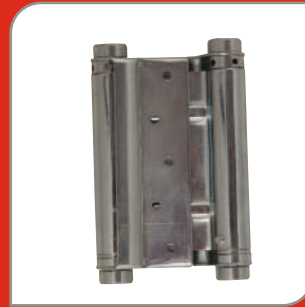

• 1072-a 33'lük Çarpma Mentese (Sac)
• 1072-b 36'lük Çarpma Mentese (Sac)



• 1075
Ahşap Kapı Mentese
Wood Door Hinge



• 1105 PVC Pencere Kolu Pls.
PVC Window Lever Plastic
• 1106 PVC Pencere Kolu Alüm.
PVC Window lever Aluminum



• 1111
İspanyolet Kol
Espagnolette Lever



• 1112
Lüks İspanyolet Kol
Luxury Espagnolette Lever



• 1113
Kancalı İspanyolet Kol
Espagnolette Lever Hook



• 1119 Eksenel Kol (Master Kol)
Axial Lever (Master)
• 1120 Eksenel Kol (Master Kol)
Axial Lever (ergonomic Master)



• 1123
Alüminyum Çift Açılım
Aluminum Double Opening



• 1121
Eksenel Kol Savio
Axial Lever Savio



• 1122
Çift Dilli Eksenel Kol
Dual lingual Axial Lever



• 1124
Eksenel Kol (Köşeli)
Axial Lever (Cornered)



• 1125
Eksenel Kol Klasik (Köşeli)
Axial Lever (Classic Cornered)



• 1127
Cephe Kolu
Facade Lever



• 1128
Cephe Kolu Eğimli
Facade Lever (inclined)



• 1129
Cephe Kolu Mekanizmalı
Facade Lever Buckle Mechanism



• 1131
Tetik Kol
Trigger Lever



• 1132
Tetik Kol Anahtarlı
Keyed Trigger Lever



• 1208 Çarpma Karşılık Dilli
Multiplication Lock Provision for lingual
• 1209 Çarpma Karşılık Makaralı
Roller Lock Provision for Multiplication

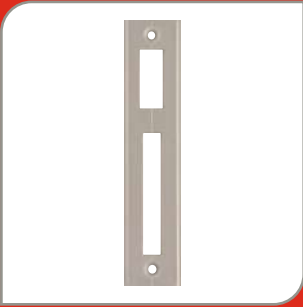

• 1211
Aldoks Dilli Kilit Karşılığı
Aldoks lingual Lock Provision

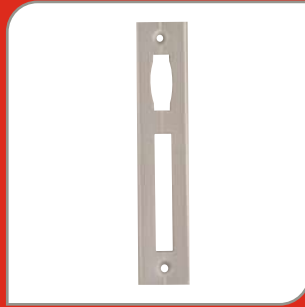

• 1212
Aldoks Makaralı Kilit Karşılığı
Aldoks Roller Lock Provision



• 1221
Isı Yalıtım Dilli Kilit Karşılığı
Heat Insulation lingual Lock Provision



• 1222
Isı Yalıtım Makaralı Kilit Karşılığı
Heat Insulation Roller Lock Provision

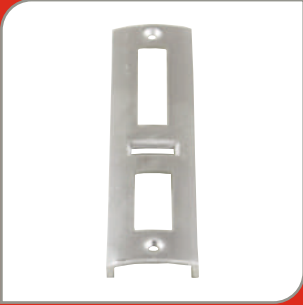

• 1231
C-60 Dilli Kilit Karşılığı
C-60 lingual Lock Provision



• 1232
C-60 Makaralı Kilit Karşılığı
C-60 Roller Lock Provision



• 1235
C-60 Dilli Kilit Karşılığı (Kalın)
C-60 lingual Lock Provision (thick)



• 1236
C-60 Makaralı Kilit Karşılığı (Kalın)
C-60 Roller Lock Provision (thick)

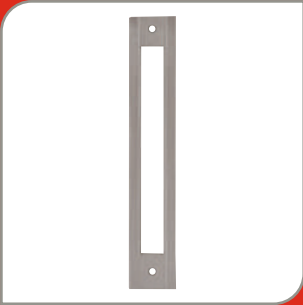

• 1233
C-60 Kilit Altı
C-60 Lock base of

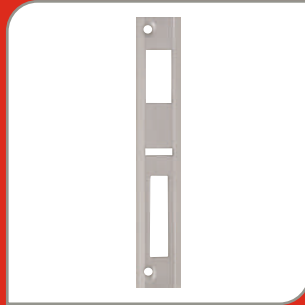

• 1241
Beysan - Feniş - Altema Dilli Kilit Karşılığı
Lingual Lock Provision

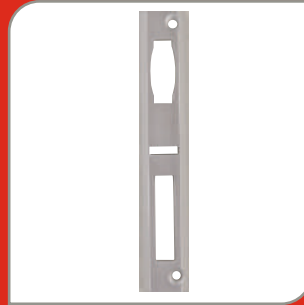

• 1242
Beysan - Feniş - Altema Makaralı Kilit Karşılığı



• 1243
Yunan Kilit Karşılığı
Greek Lock Provisions



• 1251
İspanyolet Karşılığı
Provision for Espagnolette



• 1259
Ayarlı Zamak Karşılık Üstün Vidalı
Adjustable Zamac'ı



• 1260 Ayarlı Zamak Isı Yalıtım (Setuskurlu)
,Adjustable Zamac'ı Heat Insulation
• 1261 Ayarlı Zamak Feniş (Setuskurlu),
Adjustable Zamac Feniş



• 1262
Ayarlı Zamak Karşılığı
Non-adjustable Zamac'ı



• 1263 Çephe Zamağı Üst
• 1264 Çephe Zamağı Alt
Facade Zamac'ı



• 1265
Kelebek Zamak Karşılığı



• 1271 (60 cm) Tij Cubuğu Tij rod 60 cm
• 1272 (75 cm) Tij Cubuğu Tij rod 75 cm
• 1273 (100 cm) Tij Cubuğu Tij rod 100 cm



• 1311
Aldoks Vasistas Makası 13 cm
Aldoks Transom Scissors 13 cm



• 1312
Vasistas Makası Kanala Geçmeli
Transom Scissors Channel



• 1314
Isı Yalıtım Vasistas
Thermal Insulation Transom Scissors



• 1315
Isı Yalıtım Sac Vasistas Makası
Thermal Insulation Transom Scissors (steel)



• 1316 16'lık Cephe Makası
• 1317 22'lik Cephe Makası
• 1318 26'lık Cephe Makası
Facade Scissors (16-22-26)



• 1319
Ayarlı Makas
Adjustable scissors



• 1321
Aldoks Çit Çit
Multiplication Aldoks



• 1322
Çit Çit Isı Yalıtım
Heat Insulation Multiplication



• 1323
Çit Çit PVC Doğrama İçin
Multiplication for Pvc



• 1331
Panjur Makası
Shutter Scissors



• 1410
Akbank Kol Aparatı (Yandan)
(Tapalar Opsiyondur)
Akbank Arm Apparatus (side)

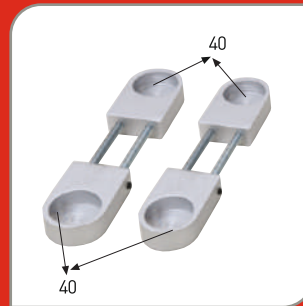

• 1411
Akbank Kol Aparatı (Havuzlu)
Akbank Arm Apparatus (pool)

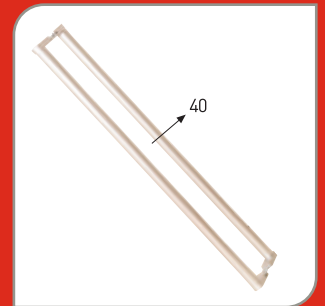

• 1412 (220 cm) Akbank Kol
Akbank Arm Tool (2.20 cm)
• 1413 (250 cm) Akbank Kol
Akbank Arm Tool (2.50 cm)



- 1421 (70 cm)
 - 1422 (80 cm)
 - 1423 (90 cm)
 - 1424 (100 cm)
 - 1425 (110 cm)
 - 1426 (120 cm)
- S Kol (Ziraat Kol) " S" Arm



- 1431 (40 cm)
 - 1432 (50 cm)
 - 1433 (60 cm)
 - 1434 (70 cm)
 - 1435 (80 cm)
 - 1436 (90 cm)
- Yay Kol Bow Arm



- 1441 (70 cm)
 - 1442 (80 cm)
 - 1443 (90 cm)
 - 1444 (100 cm)
 - 1445 (110 cm)
 - 1446 (120 cm)
- Lama Kol Flat Bar (Band) Arm



H Kol
H Arm

- 1451 (30 cm)
- 1452 (40 cm)
- 1453 (50 cm)
- 1454 (60 cm)
- 1455 (70 cm)
- 1456 (80 cm)
- 1457 (90 cm)
- 1458 (100 cm)



H
Köşeli Kol

- 1461 (30 cm)
 - 1462 (40 cm)
 - 1463 (50 cm)
 - 1464 (60 cm)
 - 1465 (70 cm)
 - 1466 (80 cm)
 - 1467 (90 cm)
 - 1468 (100 cm)
- Cornered "H" Arm



- 1499
- Banik Kol
Banik Arm



- 1500
- H Kol Pleksi (Çap 30)
H Arm Plexi (diameter 30)

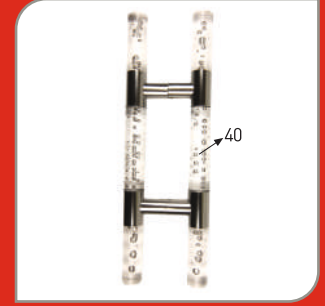

- 1503
- H Kol Pleksi (Çap 40)
H Arm Plexi (diameter 40)



- 1507
- H Kol Köşeli Pleksi
H Arm Adjustable Plexi Cornered

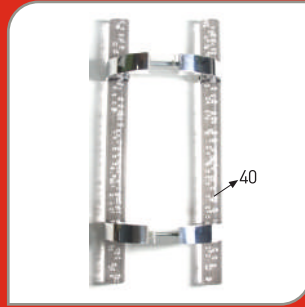

- 1508
- H Kol Köşeli Ayarlı Pleksi
H Arm Adjustable Plexi Cornered

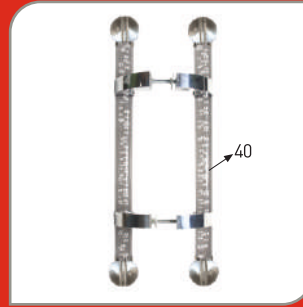

- 1510
- H Kol Köşeli Ayarlı Pleksi Topuzlu Lüks
H Arm Adjustable Plexi Cornered (with knob) Lüks

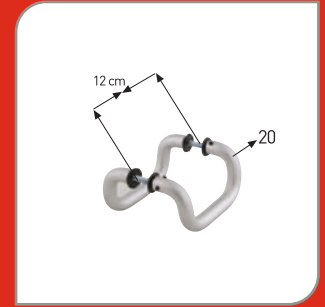

- 1511
- Mini Kıvrık Kol
Mini Curved Arm



- 1521 (20 cm)
 - 1522 (30 cm)
 - 1523 (35 cm)
 - 1524 (40 cm)
 - 1525 (50 cm)
 - 1526 (60 cm)
- Kıvrık Kol - Curved Arm



- 1551
- Ay Kıvrık Kol
Month Curved Arm

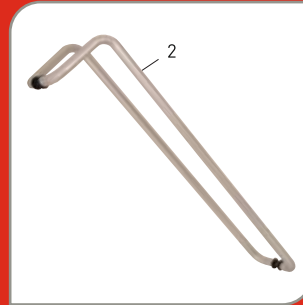

- 1571 (90 cm)
 - 1572 (100 cm)
 - 1573 (110 cm)
 - 1574 (120 cm)
- Baston Kol - L Cane Handle

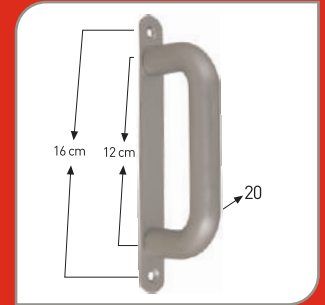

- 1601
- Aynalı Çekme Kol
Pull handle with rozette

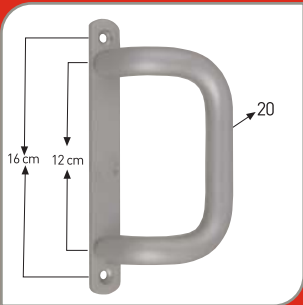

- 1611
- Aynalı Kıvrık Çekme Kol
Curved Pull handle with rozette

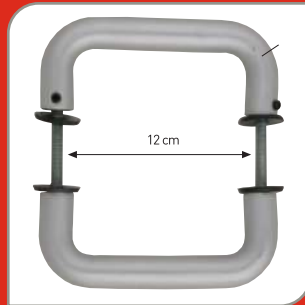

- 1621
- Mini U Çekme Kol
Small U Pull Handle



U Çekme Kol U Pull Handle

- 1631 (20 cm)
- 1632 (30 cm)
- 1633 (40 cm)
- 1634 (50 cm)
- 1635 (60 cm)
- 1636 (70 cm)
- 1637 (80 cm)
- 1638 (90 cm)



- 1641
- Havuz Kol
Closing gear for sliding



• 1642
Havuz Kol Döküm Büyük

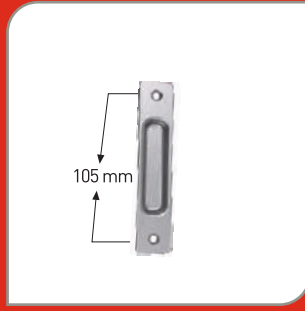

• 1643
Havuz Kol Döküm Küçük



• 1651
Kare Kol
Square Pull Handle



• 1671
Yarım Ay Kol
"C" Casted Pull Handle



• 1672
Yarım Ay Kol (Oval)
"C" Pull Handle (pipe)



• 1681
D-Kol
"D" Pull Handle



• 1683
D-Kol Lüks
"D" Luxury Pull Handle



• 1684
D-Kol Sineklik
"D" flapper Pull Handle



• 1691
C-Kol
"C" Pull Handle



• 1701
Parmak İzli Sosis Kol
Fingerprint double Pull Handle



• 1702
Sosis Kol
Sausages flat arm



• 1703
Babacan Sosis Kol
Sausages Arm twisted



• 1706
Yaylı Sosis Kol
Return spring Arm Sausage



• 1707
Yaylı Px Kol
Return Spring Luxury Arm



• 1708
Yuvarlak Rozetli Sosis Kol (Barel Rozetleri Opsiyondur)
Sausage Arm Round Rosette



• 1709
Babacan Rozetli Sosis Kol (Barel Rozetleri Opsiyondur)
Twisted double door handle with rosette



• 1710
Lüks Yaylı Sosis Kol



• 1713
Rozetli Sosis Kol (Barel Rozetleri Opsiyondur)
Double door handle with rosette



• 1714
Sosis Kol Aynalı
Double door handle with escutcheon



• 1715
Sosis Kol Aynalı WC
Double door handle with escutcheon (WC)



• 1716
Aynalı Barelli Çekme Kol
Door pull arm with escutcheon



• 1717
Aynalı Babacan Sosis Kol WC
Twisted Double door handle with (WC)



• 1721
Ekol Yaylı Savio Kol (Barel Rozetleri Opsiyondur)
Double door Handle return spring savio



• 1731
Ekol Aynalı Yaylı Savio Kol
Double door Handle return spring savio escutcheon



• 1732
Ekol Aynalı Yaylı Savio Kol WC
Double door Handle return spring savio escutcheon (WC)



• 1735 PVC Kapı Kolu Pls.
PVC Plastic Door Handle
• 1736 PVC Kapı Kolu Alüm
PVC Door Handle Aluminum.

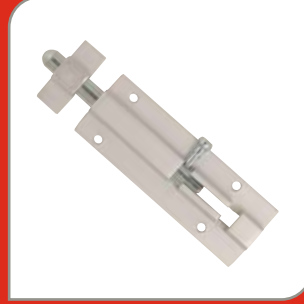

• 1811
Fişek Sürgü
Locking bolt



• 1821
Gömme Sürgü
Recessed bolt



• 1831
Sistem Sürgü Savio (Uzun)
Heat insulation bolt (long)



• 1832
Sistem Sürgü Dar Uzun
Long narrow heat insulation bolt



• 1833
Sistem Sürgü Savio Kısa
Heat insulation bolt short



• 1834
Sistem Sürgü Dar Kısa
Heat insulation the short narrow bolt



• 1870
Kapı Stoperi
Door stopper



• 1871
Emniyet Kilidi (Hırsız Kilidi)
The safety lock



• 1872 Sürme Kilit Anahtarsız
Sliding locks
• 1873 Sürme Kilit Anahtarlı
Sliding locks keyed



• 1901
Otomatik Makara
Automatic spool



• 1911
Kasnak
Pulley



• 1912
Boru Başı
Pipe Top



• 1913
Takoz
Chock



• 1941
Panjur Kilidi
Shutter Lock



• 1942
Panjur Kiliti Plastik
PVC Shutter Lock



• 1951
Kordon
Cordon



• 1961
Sac Makara
Steel Spool



• 1972
Cam Klipsi (6 mm - 9 mm - 11 mm
12 mm - 14 mm - 16 mm)



• 1975 Panjur Yatađı Sac 20'lik
Shutter Bearing box Steel (20)
• 1976 Panjur Yatađı Sac 22'lik
Shutter Bearing box Steel (22)



• 1981
L - Stop
L stop



• 2001
67'lik Plastik Rulman (Sac Gvde)
Plastic roller (67)



• 2002
67'lik Pirinç Rulman (Sac Gvde)
Brass roller (67)



• 2003
67'lik Tuba Rulman (Alminyum Gvdeli)
Single roller 67 (Aluminum)



• 2004
67'lik Tuba Plastik Rulman
(Alminyum Gvde)
Single roller pvc 67 (Aluminum)



• 2005
67'lik Çiftli Plastik Rulman (Sac Gvde)
Double plastic roller (67)



• 2006
67'lik Çiftli Pirinç Rulman (Sac Gvde)
Double brass roller (67)



• 2007
67'lik Çiftli Plastik Rulman
(Alminyum Gvde)
Double plastic roller 67 (Aluminum)



• 2008
67'lik Çiftli Pirinç Rulman
(Alminyum Gvde)
Double brass roller 67 (Aluminum)



• 2011
100'lk Plastik Rulman (Sac Gvde)
Plastic roller (100)



• 2012
100'lk Pirinç Rulman (Sac Gvde)
Brass roller (100)



• 2013
100'lk Çiftli Plastik Rulman
• 2014
100'lk Çiftli Sarı Rulman



• 2015- a
Tekli Ayarlı Plastik Rulman (Alminyum Gvde)
• 2015- b
Tekli Ayarlı Sarı Rulman (Alminyum Gvde)



• 2016-a
Çiftli Ayarlı Plastik Rulman (Alminyum Gvde)
• 2016-b
Çiftli Ayarlı Sarı Rulman (Alminyum Gvde)



• 2017-a
Uranyum SLS 33 Serisi Rulman Sarı
• 2017-b
Uranyum SLS 33 Serisi Rulman Plastik



- 2018-a Ayarlı Çiftli Rulman Sarı
- 2018-b Ayarlı Çiftli Rulman Plastik



- 2017-a Uranyum SS68 Rulman Sarı
- 2017-b Uranyum SS68 Rulman Plastik



- 2018-a Çuhadaroğlu Sürme Teker Sarı
- 2018-b Çuhadaroğlu Sürme Teker Plastik



- 2019-a Ayarlı Rulman Saç Gövde Sarı
- 2019-b Ayarlı Rulman Saç Gövde Plastik



- 2019-a Rescare Tekli Rulman Sarı
- 2019-b Rescare Tekli Rulman Plastik



- 2020-a Ayarlı Çiftli Sarı Rulman
- 2020-b Ayarlı Çiftli Plastik Rulman



- 2021-a Rescare Çiftli Rulman Sarı
- 2021-b Rescare Çiftli Rulman Plastik



- 2022-a Omega plastik gövde rulman sarı
- 2022-b Omega plastik gövde rulman plastik



- 2031 Sineklik Plastik Rulman (Sac Gövde)
- Plastic roller flapper



- 2032 Sineklik Piriç Rulman (Sac Gövde)
- Brass roller flapper



- 2033 Sineklik Rulman Plastik (Saç Gövde)



- 2034 Sineklik Rulman Sarı (Saç Gövde)



- 2041 Cam Rulmanı
- Glass roller



- 2051 Tij Pimi Aldoks
- Aldoks Tij pawl

- 2052 Tij Pimi Isı Yalıtım
- Heat insulation Tij pawl



- 2111 Tahta Fırça
- Wood brush



- 2112 (90 cm) Alüminyum T Fırça
- Aluminum Brush T



- 2114 (90 cm) Alüminyum H Fırça
- Aluminum brush H



- 2121 Aldoks Alyan Bağlantı
- Aldoks Allen the Connection



- 2130 Yunan Alyan Bağlantı Sac
- Greek Allen the Connection steel



- 2131 (19 mm) Yunan Alyan Bağlantı Zamak
- Greek Allen the Connection (zamac)



• 2141
Dar - U
Narrow " U " Connection



• 2142
Geniş - U
Large " U " Connection

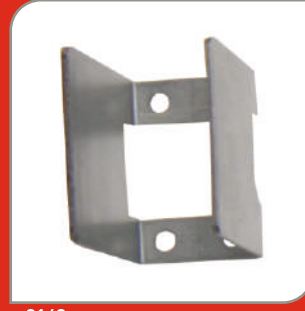

• 2143
C-60 Geniş-U Bağlantı
C-60" U " the Connection large



• 2145
Isı Yalıtım L Bağlantı



• 2151
Saplama
Screw bolt



• 2158 (80'lik) • 2159 (100'lik)
• 2160 (120'lik) • 2161 (150'lik)
Cephe Ankrāj Demiri - U
Facade Ankrāj - U Iron



• 2162 (80'lik) • 2163 (100'lik)
• 2164 (120'lik) • 2165 (150'lik)
Cephe Ankrāj Demiri - L
Facade Ankrāj - L Iron



• 2170 (80'lik) • 2171 (100'lik)
• 2172 (120'lik) • 2173 (150'lik)
Cephe Ankrāj Demiri - F
Facade Ankrāj - F Iron



• 2178
Granit Cephe L Ankrāj (80,100,120,150)



• 2179
Katlanır Cam Toplama Mekanizması
(2'li - 3'lü - 4'lü - 5'li - 6'lı - 7'li)



• 2181
Perçin
Rivets



• 2311
Sineklik Mentеше 10x20
Flapper Hinge 10 x 20



• 2312
Sineklik Köşe 17x25
Flapper Hinge 17 x 25



• 2322
90'lık Sineklik Köşe 10x20
Flapper Corner 90* 10 X 20



• 2332
90'lık Sineklik Köşe 17x25
Flapper Corner 90* 17 X 25



• 2341
Sineklik Köşe 20x40
Flapper Corner 90* 20 X 40



• 2345
Sineklik Köşe 17x42
Flapper Corner 90* 17 X 42



• 2350
Sineklik Çit Çit Mobilya Tip
Flapper multiplication Furniture Type



• 2352
Sineklik Çit Çit 17x25
Flapper multiplication



• 2354
Mıknatıslı Çit Çit
Magnet Multiplication



• 2362
Dörtlü Pabuç 17x25
Four foot 17 x 25



• 2371
Halka
Holding Ring



• 2372
Halka Altı
Ring connection

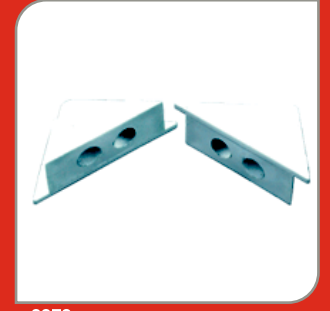

• 2373
Payanda
Buttress



• 2381
Kaşık Tutamak Kol
Spoon Plastic Arm



• 2383
L Tutamak Kol
L Plastic Arm



• 2391
Sineklik Fitol Takma Aparatı
Flapper wick Apparatus



• 2392
Cam Küreği
Glass Shovel



• 2541-a VIDA Tapası Buldex
• 2541-b VIDA Tapası 4.8
• 2541-c VIDA Tapası 3.9



• 2542
12'lik Tapa
Q 12 Stopper



• 2543
Tahliye Tapası
Drain plug



• 2551
Dübel
Peg

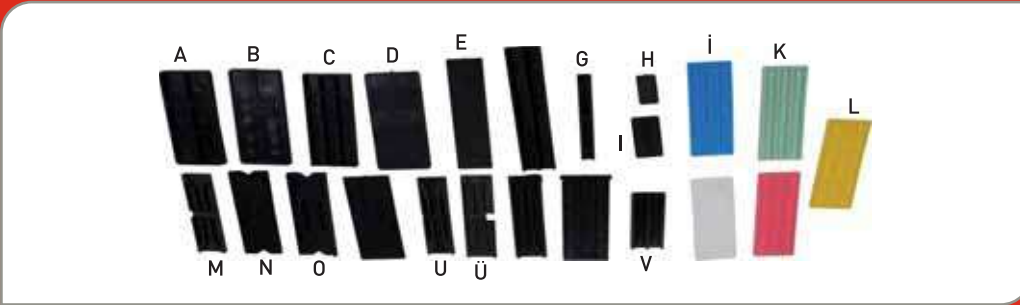

• 2571
Cam Takozu
Glass Chock



• 2580
Ayarlı Cam Takozu (18-24-32)
Adjustable Glass Chock



• 2581
Pencere Sabitleme Aparatı



• 2634
Küpeşte Çamaşırılığı (Duvara Montaj)
Bulwarks Laundry Room (Wall)



• 2635
Küpeşte Çamaşırılığı (Boruya Montaj)
Bulwarks Laundry Room

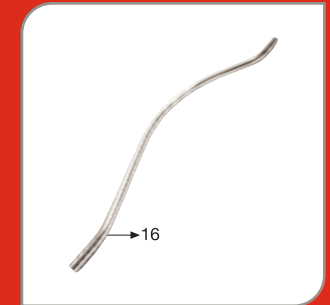

• 2640
16'lık Jumbo
Q 16 Jumbo pipe



- 2650 16'lik Dirsek 90°
- 2969 19'lik Dirsek 90°



- 2651 16'lik Dirsek 135°
- 2670 19'lik Dirsek 135°



- 2652
16'lik Ayarlı Küre [Borunun Dışına Geçen]
Q 16 Adjustable Sphere (passing out of the pipe)



- 2655
19'lik Ayarlı Küre [Borunun Dışına Geçen]
Q 19 Adjustable Sphere (passing out of the pipe)



- 2680 50'lik Ayarlı Küre
- 2680-b 40'lik Ayarlı Küre
- 2680-c 35'lik Ayarlı Küre
- 2680-d 30'lik Ayarlı Küre



- 2681
50'lik Dirsek 135° 1/8 [İçi Boş]
Q 50 Elbow 135° * 1/8 [empty]



- 2682
50'lik Dirsek 90° 1/4 [İçi Boş]
Q 50 Elbow 90° * 1/4 [empty]



- 2683
50'lik Dirsek 180° [İçi Boş]
Q 50 Elbow 180° * [empty]



- 2684 50'lik Dirsek 135° 1/8 Bilezikli [İçi Boş]
- 2684-b 40'lik Dirsek 135° 1/8 Bilezikli [İçi Boş]
- 2684-c 35'lik Dirsek 135° 1/8 Bilezikli [İçi Boş]
- 2684-d 30'lik Dirsek 135° 1/8 Bilezikli [İçi Boş]



- 2685 50'lik Dirsek 90° 1/4 Bilezikli [İçi Boş]
- 2685-b 40'lik Dirsek 90° 1/4 Bilezikli [İçi Boş]
- 2685-c 35'lik Dirsek 90° 1/4 Bilezikli [İçi Boş]
- 2685-d 30'lik Dirsek 90° 1/4 Bilezikli [İçi Boş]



- 2689
50'lik Ayarlı Küre [İçi Boş]
Q 50 Adjustable Sphere [empty]



- 2690 50'lik Ayarlı Küre
- 2690-b 40'lik Ayarlı Küre
- 2690-c 35'lik Ayarlı Küre
- 2690-d 30'lik Ayarlı Küre

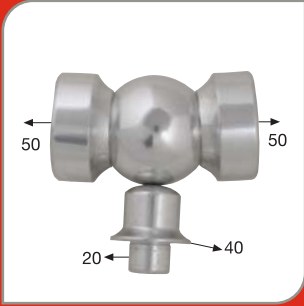

- 2691 50'lik Ayarlı Üç Ayaklı Küre
- 2691-b 40'lik Ayarlı Üç Ayaklı Küre
- 2691-c 35'lik Ayarlı Üç Ayaklı Küre



- 2692 50'lik Ayarlı Duvar Küresi (Ufo)
- 2692-b 40'lik Ayarlı Duvar Küresi (Ufo)
- 2692-c 35'lik Ayarlı Duvar Küresi (Ufo)



- 2693
50'lik Ayarlı Duvar Mafsal Takımı



- 2694
50'lik Bilezikli Ayarlı Duvar Mafsal Takımı



- 2695
50'lik Ayarlı Duvar Bağlantısı



- 2712
30'lik Boru İçin 50'lik Kurt Ağzı



- 2713
16'lik Boru İçin 50'lik Kurt Ağzı



- 2714
16'lik Boru İçin 40'lik Kurt Ağzı



• 2715
30'lık Boru İçin 50'lik Kurtağzı
30/50 dovetail



• 2716
40'lık Dikme İçin 40'lik Kurtağzı
40/40 dovetail



• 2717
40'lık Dikme İçin 50'lik Kurtağzı
40/50 dovetail



• 2718
50'lık Boru İçin 40'lik Kurtağzı
40/50 dovetail



• 2719
50'lık Boru İçin 50'lik Kurtağzı
50/50 dovetail



• 2722
Kurtağzı Duvar Arası Tek Taraf
Dovetail wall (one side)

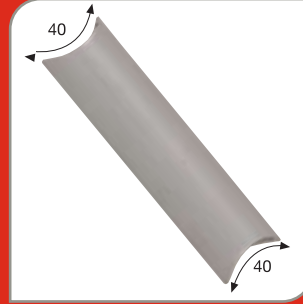

• 2723
Kurtağzı Duvar Arası Çift Taraf
Wall between dovetail (double sides)



• 2747
16'lık Boru Emniyet Tutamağı Ayarlı



• 2748
16'lık Emniyet Çubuk Tutamağı Düz (Radüslü)

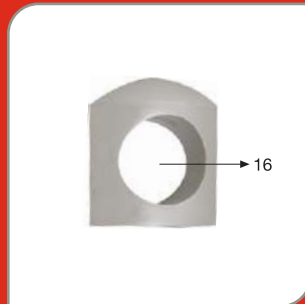

• 2749
16'lık Emniyet Çubuk Tutamağı Düz (Radüslü)
Safety rod Handle (Straight)



• 2750
16'lık Emniyet Çubuk Tutamağı Saplı
Safety rod Handle



• 2751-a
Emniyet Çubuk Tutamağı Boncuk Tipi 16'lık
Safety rod handle, bead-type



• 2751-c Emniyet Çubuk Tutamağı
Boncuk Tipi 19'lık Plastik



• 2751-b
Emniyet Çubuk Tutamağı Boncuk Tipi 19'lık
Safety rod handle, bead-type Eco

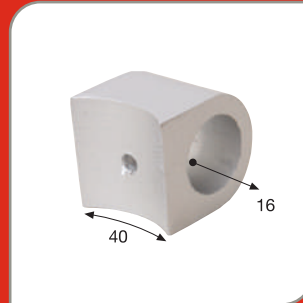

• 2752
Boruya Göre 16'lık Boru Tutamağı
Lever according to the pipe



• 2753
16'lık Boru Tutamağı

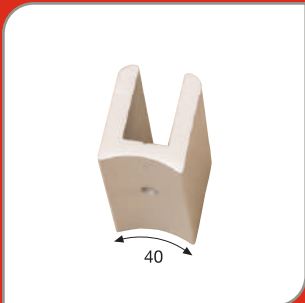

• 2760
40'lık Boruya Göre Cam Tutamağı
35'lık Boruya Göre Cam Tutamağı



• 2761
40'lık Boruya Göre Cam Tutamağı Setuskurlu
35'lık Boruya Göre Cam Tutamağı Setuskurlu



• 2762
40'lık Boruya Göre Cam Tutamağı Kapaklı
Cover Pipe glass handle



• 2764
Dikmeye Göre Cam Tutamağı
Pillar glass handle



• 2765
Dikmeye Göre Cam Tutamağı Setuskurlu
Screw pillar glass handle

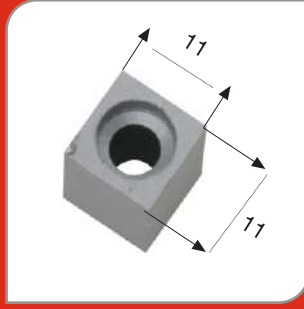

• 2766-a
Cam Takozu Alüminyum
Glass Chock aluminum

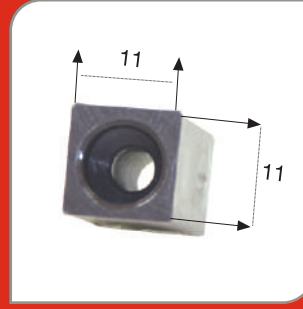

• 2766-b
Cam Takozu Plastik
Glass Chock pvc



• 2777
Spaytır Aparatı
Spider Apparatus



• 2778
Tekli Cam Spaytır
Single spider glass holder



• 2779
Çiftli Cam Spaytır
Double spider glass holder



• 2780
Tekli Cam Kelebeği
Single glass butterfly



• 2781
Çiftli Cam Kelebeği
Double glass butterfly



• 2855
16'lık Tapa Badem Modeli

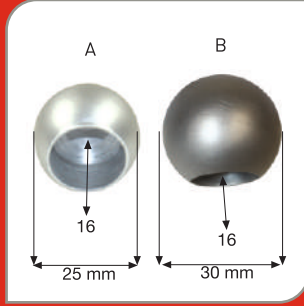

• 2859-a 16'lık Boru Tapası (Çap 25)
• 2859-b 16'lık Boru Tapası (Çap 30)



• 2860
16'lık Boru Tapası (Boru Üzerine Geçen)
• 2860-b
16'lık Boru Tapası dekorlu
(Boru Üzerine Geçen)



• 2861
16'lık Tapa (Dolu Tapası)
Q 16 plug (full cap)



• 2862
16'lık Tapa (Boş Boru Tapası)
Q 16 plug (empty pipe plug)

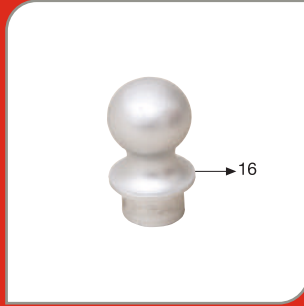

• 2863
16'lık Dekorlu Tapa
Q 16 Decorative plug



• 2864
16'lık Mızrak
Q 16 Spear



• 2865
19'lık Tapa
Q 19 plug



• 2866
30'lık Tapa
Q 30 plug



• 2866-b 30'lık Tapa (Boru Dışına Geçen)



• 2867
40'lık Tapa
Q 40 plug



• 2868
40'lık Dikme Tapası
Q 40 Pillar Plugs



• 2869
50'lik Tapa (Boru Dışına Geçen)
Q 50 plug



• 2869-b
50'lik Tapa (Boru Dışına Geçen)



• 2885
40'lik Dekorlu Tapa (Topuz)
Q 40 Decorative plug (bun)



• 2886
50'lik Dekorlu Tapa (Topuz)
Q 50 Decorative plug (bun)



• 2887
65'lik Dekorlu Tapa (Topuz)
Q 65 Decorative plug (bun)



• 2892
40'lik Dikme Tapası
Q 40 Pillar Plugs



• 2895
50'lik Kristal Topuz
Q 50 Crystal plug Decorative



• 2896
65'lik Kristal Topuz
Q 65 Crystal plug Decorative



• 2897
50'lik Pleksi Topuz
Q 50 Pleksi plug



• 2898
50'lik Pleksi Topuz Gövde Alüminyum
Q 50 Plexi Aluminium plug

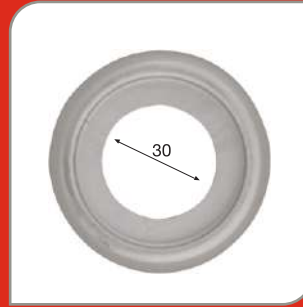

• 2900
Duvar Pulu
Wall Washer



• 2902
35'lik Pul



• 2911
16'lik Bilezik (Yüzük)
Q 16 Ring



• 2912
19'lik Bilezik
Q 19 Ring

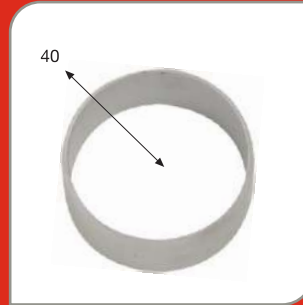

• 2918
40'lik Bilezik
Q 40 Ring



• 2920
50'lik Bilezik
Q 50 Ring

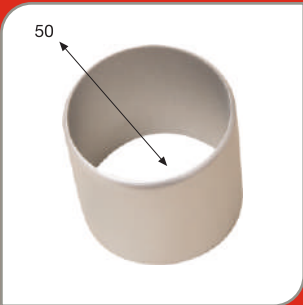

• 2925
50'lik Uzun Bilezik
Q 50 Long Ring



• 3021
30'lik Dış Flanş
Q 30 Outer Flange



• 3022
40'lik Dış Flanş
Q 40 Outer Flange



• 3023
50'lik Dış Flanş
Q 50 Outer Flange



• 3026
40'lık Uzun Dış Flanş
Q 40 Long Outer Flange



• 3027
50'lık Uzun Dış Flanş
Q 50 Long Outer Flange



• 3028
40'lık Dış Flanş Kapağı
Q 40 Outer Flange Cover



• 3029
50'lık Dış Flanş Kapağı
Q 50 Outer Flange Cover



• 3030
16'lık Dış Flanş
• 3030-b
19'lık Dış Flanş



• 3031
16'lık Duvar Flanş
Q 16 Wall Flange



• 3032
Boruya Göre 16'lık Flanş (Kurtağızlı)
Q 16 Flange dovetail (by pipe)



• 3033
30'lık Duvar Flanş
Q 30 Wall Flange

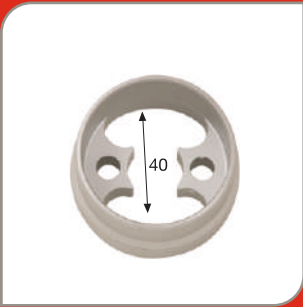

• 3034
40'lık Boru Flanş
Q 40 Pipe Flange

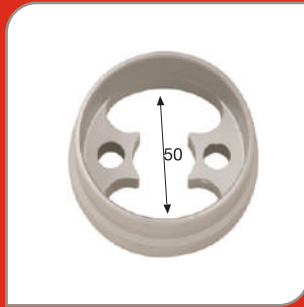

• 3035
50'lık Boru Flanş
Q 50 Pipe Flange



• 3036-a 30'lık Yer Flanşı
• 3036-k 30'lık Yer Flanşı



• 3037-a
35'lık Yer Flanşı Saplı
Q 35 Place flange handle



• 3037-k
35'lık Yer Flanşı Saplı



• 3037-b
35'lık Yer Flanşı
Q 35 Place flange



• 3039
65'lık Boru Flanşı
Q 65 Pipe Flange



• 3040
40'lık Dikme Çift Tırnak Flanş (Yer Flanş)
Q 40 Pillar flange



• 3041
40'lık Dikme Tırnaksız Flanş (Yer Flanş)
Q 40 Pillar flange (Place flange)



• 3042
40'lık Dikme Tek Tırnak Flanş (Yer Flanş)
Q 40 Pillar flange single quotes



• 3043
40'lık Dikme Tek Tırnak Flanş (Dekorlu)
Q 40 Pillar flange single quotes



• 3044
40'lık Dikme Tek Tırnak Flanş (Papatya Modeli)
Q 40 Pillar flange single quotes



• 3045-a
16'lık Boru Süsü (Çap 25)
Q 16 Pipe ornament (Sphere)



• 3045-b
16'lık Boru Süsü (Çap 30)
Q 16 Pipe ornament (Sphere)



• 3045-c
16'lık Boru Süsü Topaç Modeli



• 3046-a
16'lık Boru Dekorlu Süs
16 Pipe Decorative Ornamental



• 3046-b
16'lık Boru Dekorlu Süs
16 Pipe Decorative Ornamental



• 3046-c
16'lık Boru Dekorlu Süs
16 Pipe Decorative Ornamental



• 3046-d
40'lık Dekorlu Flaş (Süs)
Q 40 Decorative Flange (ornamental)



• 3047-a
40'lık dekorlu flaş tek tırnak süs
• 3047-b
40'lık dekorlu flaş tırnaksız süs



• 3047-c
40'lık Dekorlu Flaş (Süs) Tırnaksız
Q 40 Decorative Flange (ornamental)



• 3048-b
40'lık Uzun Dikme Flaş Tek Tırnaklı
(Dereceli Kesilebilen)



• 3048-c
40'lık Uzun Dikme Flaş Tırnaksız
(Dereceli Kesilebilen)



• 3049
50'lık Uzun Boru Flaş (Dereceli Kesilebilen)
Q 50 Long Pipe Flange (Grade Sliceable)

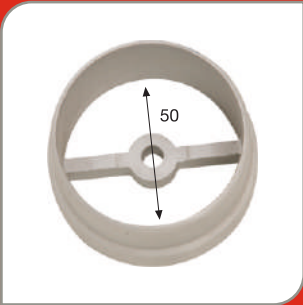

• 3050
50'lık Duvar Flaş
Q 50 Wall Flange



• 3118
30'lık Ay Bağlantısı (Mavsal Takım)
Q 30 Moon Connection



• 3119
35'lık Ay Bağlantısı (Mavsal Takım)
Q 35 Moon Connection



• 3121
40 x 50'lık Ay Bağlantısı (Mavsal Takım)
Q 40 Moon Connection



• 3121-40
40 x 40'lık Ay Bağlantısı (Mavsal Takım)
Q 40 Moon Connection



• 3122
40'lık Yayvan Ay Bağlantısı (Mavsal Takım)
Q 40 Flat Moon Connection



• 3123
35'lık Ay Bağlantısı Sabit (Dekorlu)
35 Moon Connection Fixed 35/50

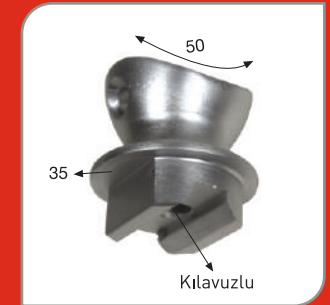

• 3123-b
35'lık Ay Bağlantısı Sabit (Dekorlu)
35 Moon Connection Fixed 35/50



• 3124
40'lık Ay Bağlantı Sabit (Dekorlu)
Q 40 Moon Connection Fixed 40/50 (Decorative)



• 3125
50'lık Ay Bağlantı (Mavsal Takım)
Q 50 Moon Connection 50/50



• 3126
50'lık Boru Bilezikli Mavsal Takımı



• 3127
Duvar Dibi Bağlantısı
Wall Connection



• 3128
Duvar Dibi Bağlantı (Eko Serisi)
Eco Wall Connection



• 3129
Duvar L Bağlantısı
Wall L Connection



• 3130
Duvar Yayvan Bağlantı
Wall Flat Connection



• 3131-a
40'lık Dikme Duvar Bağlantısı
Q 40 Pillar Wall Connection



• 3131-b
40'lık Dikme Duvar Bağlantısı Tırnaksız
Q 40 Pillar Wall Connection (unquoted)

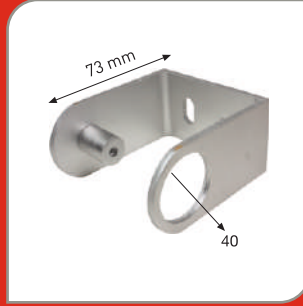

• 3132-a
40'lık Dikme Bağlantı (U)
Q 40 Pillar Connection (U)

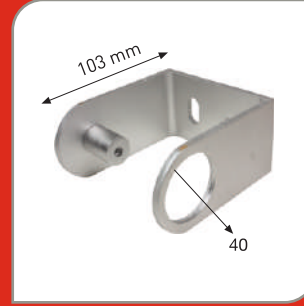

• 3132-b
40'lık Dikme Bağlantı Uzun (U)
Q 40 Pillar Connection (U)



• 3132-c
35'lık Dikme Bağlantı Uzun (U)
Q 40 Pillar Connection (U) Long



• 3133
40'lık Dikme Duvar Bağlantısı (Uzun)
Q 40 Pillar Wall Connection long



• 3133-b
40'lık Dikme Duvar Bağlantısı (Uzun)
Q 40 Pillar Wall Connection long

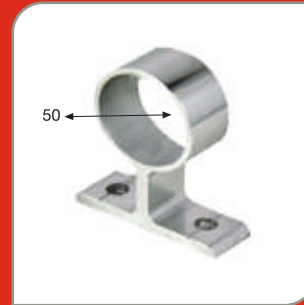

• 3134
50'lık Boru Duvar Bağlantısı
Q 50 Pipe Wall Connection



• 3135
50'lık Boru İç Takozu
Q 50 Pipe Chock Interconnection



• 3136
65'lık Boru İç Takozu
Q 65 Pipe Chock Interconnection



• 3140
Küpeşte Menteşesi
Bulwarks Hinge



• 3141
Küpeşte Menteşesi (Aldoks Modeli)
Bulwarks Hinge Aldoks



• 3143
Küpeşte Sürgüsü
Bulwarks Slider



• 3212
40'lık Dikme Ankraj Demiri Kısa (İç Boş)
Q 40 Pillar Angraj Iron Short (empty)



• 3213
40'lık Dikme Ankraj Demiri Uzun (İç Boş)
Q 40 Pillar Angraj Iron Long (empty)



• 3214
40'lık Dikme Ankraj Demiri Uzun (İç Dolu)
Q 40 Pillar Angraj Iron Short (full)



• 3215
40'lık Dikme Ankraj Demiri Kısa (İç Dolu)
Q 40 Pillar Angraj Iron Long (full)



• 3216
40'lık Dikme Ankraj Demiri Vidalı
Q 40 Pillar Angraj Iron Long



• 3218
Yandan Montaj Ankraj Demiri
Side Mounting Iron Angraj



• 3150
Kimyasal Harç
Chemical Mortar(epoksil)



• 3151
Kimyasal Tabanca
Chemical Gun



• 3155
Köpük Tabancası
Foam Gun



• 3156
Mastik Tabancası
Mastic Gun



• 3168 M8 Çekmeli Dübel
Pull Peg
• 3169 M8 Gijon 100 cm
Gijon (stub)



• 3170 M10 Dübel (Klipsli) 85 mm ve 110 mm
• 3180 M10 Dübel (Gömektli) 85 mm ve 110 mm
• 3181 M10 Çivata + Pul + Somun 85 mm ve 110 mm



• 3185 Mastik • 3187 Köpük Tabancalı
• 3186 Silikon • 3188 Köpük Tabancasız
• 3189 Deniz Tutkalı



• 3193 Kıl Fital Sürme
• 3194 Kıl Fital Panjur



• 3195
Sineklik Tül Flapper Tulle



• 3198
Panjur Kolu



• 5000
Pleksi Dikme Baba



• 5002
Pleksi Dikme Baba



• 5004
Pleksi Dikme Baba



• 5010
Pleksi Dikme

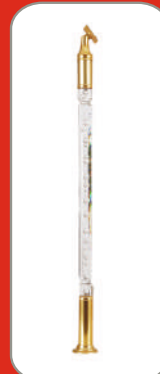

• 5012
Pleksi Dikme



• 5014
Pleksi Dikme

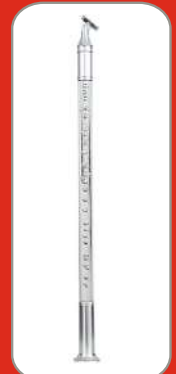

• 5016
Pleksi Dikme



- 6000 25 x 60 Ayarlı Dönüş
- 6001 30 x 80 Ayarlı Dönüş



- 6002 25 x 60 Mafsallı Dönüş
- 6003 30 x 80 Mafsallı Dönüş



- 6004 25 x 60 Bilezikli Ayarlı Dönüş
- 6005 30 x 80 Bilezikli Ayarlı Dönüş



- 6006 25 x 60 Bilezikli Mafsallı Ayarlı Dönüş
- 6007 30 x 80 Bilezikli Mafsallı Ayarlı Dönüş



- 6008 25 x 60 Çok Hareketli Dönüş
- 6009 30 x 80 Çok Hareketli Dönüş



- 6010 25 x 60 Çok Hareketli Mafsallı Dönüş
- 6011 30 x 80 Çok Hareketli Mafsallı Dönüş



- 6012 25 x 60 Bilezikli Hareketli Dönüş
- 6013 30 x 80 Bilezikli Hareketli Dönüş



- 6014 25 x 60 Tek Yönlü Dönüş
- 6015 30 x 80 Tek Yönlü Dönüş



- 6020 14 x 14 Dirsek 90°
- 6021 15 x 15 Dirsek 90°



- 6022 14 x 14 Dirsek 135°
- 6023 15 x 15 Dirsek 135°



- 6024 14 x 14 Ayarlı Küre
- 6025 15 x 15 Ayarlı Küre



- 6026 14 x 14 Aşağı Yukarı Hareketli Küre
- 6027 15 x 15 Aşağı Yukarı Hareketli Küre



- 6028 14x14 Dıştan Geçme Hareketli Küre



- 6029 40x40 Hareketli Mafsallı Lamalı



- 6030 40 x 40 Hareketli Mafsallı Takımı



- 6031 40 x 40 Yayvan Mafsallı Takımı



- 6032 40 x 40 Sabit Mafsallı



- 6033 60x25 Duvar Flanşı Camlı
- 6034 80x30 Duvar Flanşı Camlı



- 6035 60x25 Duvar Flanşı
- 6036 80x30 Duvar Flanşı



- 6037 25 x 60 Duvar Flanşı
- 6038 30 x 80 Duvar Flanşı



• 6039 25 x 60 Camlı Duvar Flanşı
• 6040 30 x 80 Camlı Duvar Flanşı

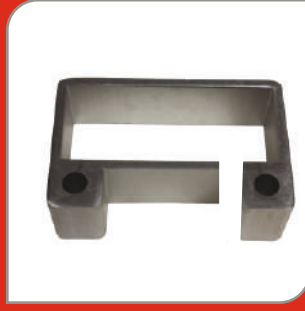

• 6041 25 x 60 Camlı Duvar Flanşı
• 6042 30 x 80 Camlı Duvar Flanşı



• 6043
40x40 Sabit Mafsallı Lamalı



• 6044 40 x 40 Dikme Duvar Bağlantısı



• 6045 40 x 40 Dış Flanş



• 6050
40 x 40 Yer Flanşı



• 6055
70 x 70 Yer Flanşı



• 6060
Kare Cam Tutamağı



• 6061
Kare Cam Tutamağı Setuskurlu

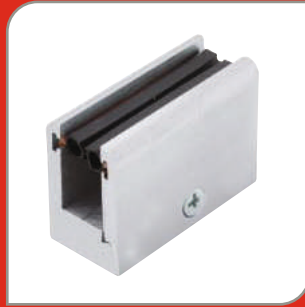

• 6065
Kare Kapaklı Cam Tutamağı



• 6070
14 x 14 Bilezik
• 6071
15 x 15 Bilezik

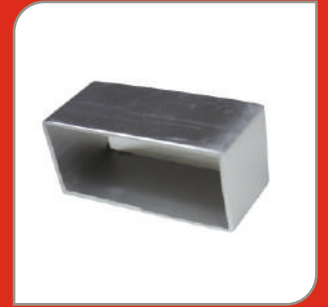

• 6075
25 x 60 Bilezik
• 6080
30 x 80 Bilezik



• 6090
40 x 40 Tapa
• 6095
70 x 70 Tapa



• 6098
60x25 Diştan Geçme Tapa
• 6099
80x30 Diştan Geçme Tapa

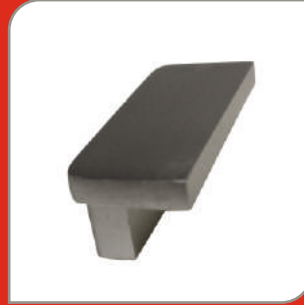

• 6100
25 x 60 Tapa
• 6103
30 x 80 Tapa



• 6105
14 x 14 Tapa
• 6106
15 x 15 Tapa



• 6110
14 x 14 Topuz
• 6111
15 x 15 Topuz



• 6115
40 x 40 Topuz
• 6118
70 x 70 Topuz



• 6120
40 x 40 Kristal Topuz



• 6125
70 x 70 Kristal Topuz



• 6130
25 x 60 Ayarlı Duvar Flanşı



• 6140
14 x 14 Profil Tutamağı Saplı
• 6145
15 x 15 Profil Tutamağı Saplı



• 6150
14 x 14 Profil Tutamağı Sapsız
• 6155
15 x 15 Profil Tutamağı Sapsız

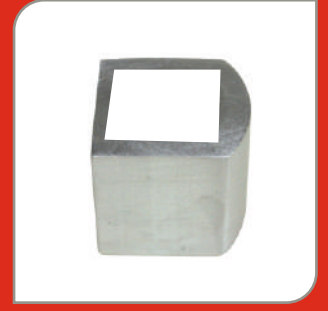

• 6160
14 x 14 Profil Tutamağı Köşeli
• 6165
15 x 15 Profil Tutamağı Köşeli



• 6170
14 x 14 Ara Bağlantı
• 6175
15 x 15 Ara Bağlantı



• 6180
40 x 40 Dikme Bağlantı (U)



• 6182
60x25 Hareketli Dirsek Çift Açılı Mafsallı
• 6183
80x30 Hareketli Dirsek Çift Açılı Mafsallı



• 6184
60x25 Topuz Dirsek

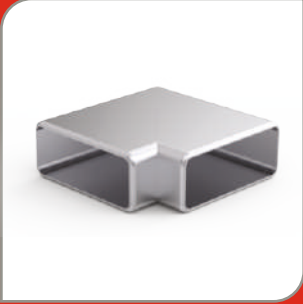

• 6186
60x25 Dirsek 90°
• 6187
80x30 Dirsek 90°

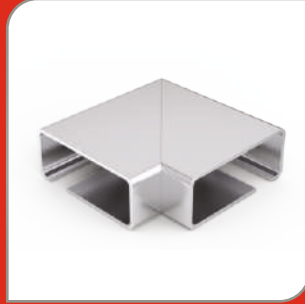

• 6188
60x25 Önden Kanallı Dirsek 90°
• 6189
80x30 Önden Kanallı Dirsek 90°



• 6191
60x25 Ortadan Kanallı Dirsek 90°
• 6192
80x30 Ortadan Kanallı Dirsek 90°



• 6193
60x25 Dirsek 45°
• 6194
80x30 Dirsek 45°



• 6195
60x25 Önden Kanallı Dirsek 45°
• 6196
80x30 Önden Kanallı Dirsek 45°



• 6197
60x25 Ortadan Kanallı Dirsek 45°
• 6198
80x30 Ortadan Kanallı Dirsek 45°



• 6199
60x25 Ayarlı Duvar Flanşı
• 6200
80x30 Ayarlı Duvar Flanşı



• 6201
60x25 Hareketli Dirsek Tek Açılı
• 6202
80x30 Hareketli Dirsek Tek Açılı



• 6203
60x25 Hareketli Dirsek Çift Açılı
• 6204
80x30 Hareketli Dirsek Çift Açılı



• 6205
60x25 Hareketli Dirsek Tek Açılı Mafsallı
• 6206
80x30 Hareketli Dirsek Tek Açılı Mafsallı



• 6207
40x25 Hareketli Mafsal Takımı

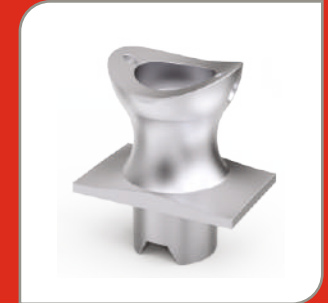

• 6208
40x25 Sabit Mafsal



•6209
40x25 Dikme Flanşı

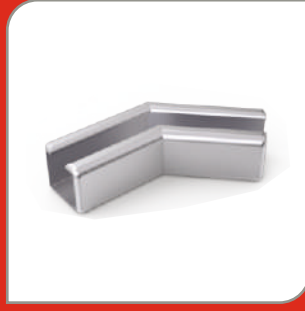

•6210
16x22 Dirsek 45°



•6211
16x22 Dirsek 90°



•6212
30x25 Duvar Flanşı

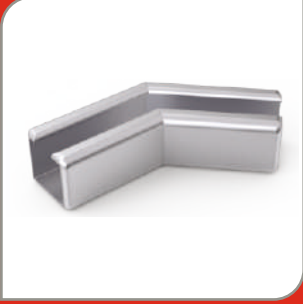

•6213
30x25 Dirsek 45°



•6214
30x25 Dirsek 90°



•6215
30x25 Tapa



•6216
14x14 Boru Jumbo
•6217
16x16 Boru Jumbo

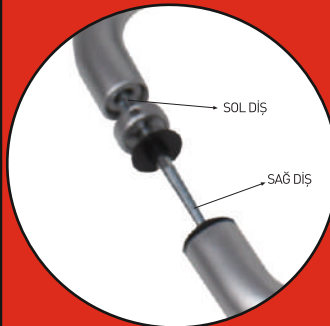
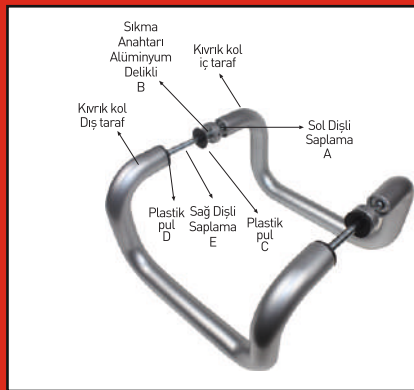

Not: Bu model ile setuskur gevşemelerine son.



• 6190
Cam Tutamağı Fitolü



STAND 1



STAND 2



STAND 3

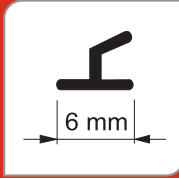

• 2411
Aldoks Fitolü Aksan

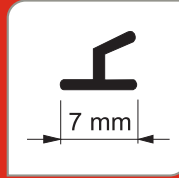

• 2412
Aldoks Fitolü Gaziođlu

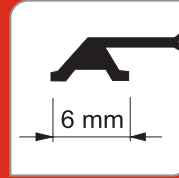

• 2413
Aldoks İtalyan Fitolü

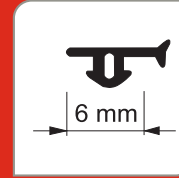

• 2415
Çakma Maçalı Fitolü

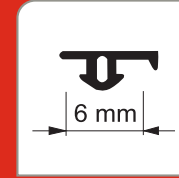

• 2416
Dragon Conta

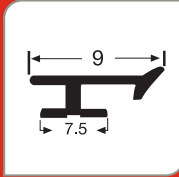

• 2418
Maçalı Fitolü



• 2419
C-60 Fitolü

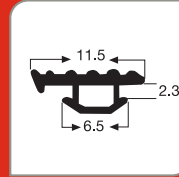

• 2420
C-60 Fitolü

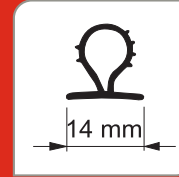

• 2422 (3 mm) Cam Fitolü
• 2423 (4 mm) Cam Fitolü
• 2424 (6 mm) Cam Fitolü



• 2425
Gama Fitolü

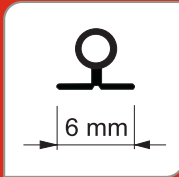

• 2426
Omega Fitolü

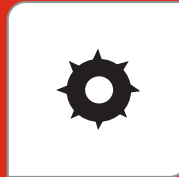

• 2429 (4 mm)
• 2430 (5 mm)
Sineklik Fitolü



• 2434
Deliklik Leksan



• 2435
Leksan Giydırme

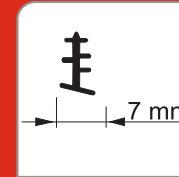

• 2436
Cam Fitolü Çift Taraflı

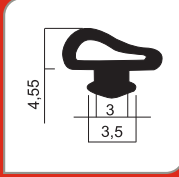

• 2438
Kasa Bini Fitolü

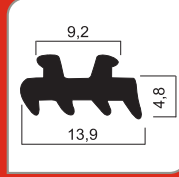

• 2439
Yalıtım Fitolü



• 2440
Cam Cephe Fitolü



• 2441
Cam Cephe Dış Fitolü



• 2442
Cam Cephe Orta Fitolü



• 2443
60 Bini Fitolü



• 2444
Cephe Kapama Fitolü

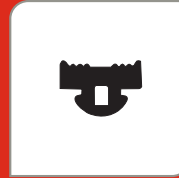

• 2445
Cephe Fitolü



• 2446
Cephe Fitolü

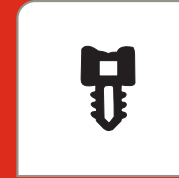

• 2447
Cephe Orta Fitolü

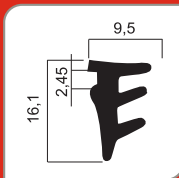

• 2449
Isı Yalıtım İç Cam Fitolü

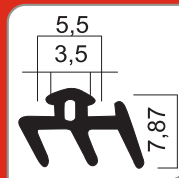

• 2450
Isı Yalıtım Cam Fitolü

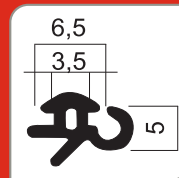

• 2451
Isı Yalıtım Kanat Fitolü

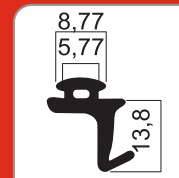

• 2452
Isı Yalıtım Orta Fitolü



• 2453
Isı Yalıtım Kasa Fitolü



Adress: Zafer Mahallesi, Dođan Araslı Blv. No:97/99, 34510 Esenyurt / İstanbul - NCadde Business Plaza

Tel : +90 212 999 51 57 WhatsApp : +90 533 671 10 56

www.aluminsan.com.tr/ export@aluminsan.com.tr