

ALUMINAKS
ALUMINIUM & ACCESSORIES

GAUGE PROFILES
MASTAR PROFİLLERİ



ALUMINAKS

ALUMINIUM & ACCESSORIES

GAUGE PROFILES



European Standard (EN)



quality



ALUMINAKS

ALUMINIUM & ACCESSORIES



<p>HAKKIMIZDA</p> <p>Ülkemizin yenilikçi firmalarından biri olan ALUMİNAKS METAL alüminyum ve aksesuar sektöründe faaliyetlerini sürdürmektedir.</p> <p>Türkiye’de göstermiş olduğu başarısının yanında; Avrupa, Amerika, Afrika, Ortadoğu gibi bölgelerde bulunan tüm dünya ülkelerine ihracat yaparak kendi isminden söz ettirmeye devam etmektedir. Alüminyum sektöründe elde etmiş olduğu birikimlerini, kalite ve Arge yatırımına ayırmıştır</p> <p>ALUMİNAKS ayrıca kısa üretim süresi ile birlikte yüksek kalitesinden ödün vermeden bir çok farklı ülkeye ihracat yapmaktadır.</p> <p>Temel hedefi ve kalite politikası, her zaman müşterilerinin taleplerini yerine getirmektir. Sahip olduğu yüksek kalite ve sorunsuz paketlemesinin yanında müşterilerine zamanında ve hızlı teslim süresi sağlaması ve uygun fiyatlandırma sayesinde alüminyum profil sektöründe kendini kanıtlamayı başarmıştır.</p>	<p>ABOUT US</p> <p>ALUMİNAKS METAL, which is one of the innovative companies in Turkey, continue its activities in the aluminium and accessory sector.</p> <p>ALUMİNAKS has already reached its target in the local market, as well as it is well known by exporting to Europe, America, Africa, Middle East region from all over the World. ALUMİNAKS keep putting its revenue that it get from aluminium sector to quality and R & D (Research And Development) investment. Beside these, ALUMİNAKS has very short production time and it exports to the most of different countries without compromising from its quality.</p> <p>ALUMİNAKS has main target and quality policy always meet its customers' requirements. ALUMİNAKS also achieved to prove itself through high quality production and perfect packing with fast and in time delivery and best quotation.</p>
<p>EXTRÜZYON</p> <p>Tesisimizde tam otomatik iki adet Alüminyum Ekstrüzyon Presi bulunmaktadır</p> <p>Çok geniş bir ürün yelpazesinde, muhtelif sektörlerle ve kullanım amaçlarına yönelik alüminyum profillerin imalatı ekstrüzyon hatlarımızda gerçekleştirilmektedir.</p> <p>Ekstrüzyon hatlarımızda kullanılan biletler kesinlikle en iyi niteliklere sahip 1.sınıf alüminyum biletler olup üretimimizde özel alaşımli profiller imal edilmektedir.</p> <p>Ekstrüzyon işleminin her aşamasında sürekli kontrollerle kaliteyi üretmekteyiz.</p> <p>Yıllık kapasite 8.500 ton kapasite ve profil üretimindeki deneyim ve teknoloji ile sektörde faaliyet göstermektedir</p>	<p>EXTRUDING</p> <p>We have full automatic Aluminium extrusion line in our factory. We carry out the production of aluminium profiles that come in a wide range of products for various sectors and various purposes in our extrusion department.</p> <p>The billets used in our extrusion lines are first class aluminium billets with the best qualities; these ensure for special alloy profiles to be manufactured in our facilities.</p> <p>We ensure quality through constant controls in every stage of the extrusion process.</p> <p>The company operates in the sector with an annual production capacity of 8.500 tonnes and a great level of experience and technology in profile production.</p>
<p>ELOKSAL</p> <p>Eloksal tesisimiz AB standartları içerisinde üretim yapan ve son teknolojiye sahip 7 mt boyunda profillere eloksal yüzey işlemi yapabilmektedir.</p> <p>Eloksal tesisimizde polisajlı ve değişik renk tonlarında açık bronzdan, kahverengi tonlarına kadar siyah, sarı, natürel alüminyum renginde eloksal renkleri yapılmaktadır</p>	<p>ANODISING</p> <p>Our anodising facility has the capacity to treat 7-meter long profiles with the latest technologies and in compliance with EN standards.</p> <p>The facility makes it possible for anodising to be provided with polish and many colours, varying from light bronze and brown to black, yellow and natural aluminium shades.</p>
<p>ELEKTROSTATİK TOZ BOYA</p> <p>Müşterilerimizden gelen talepler doğrultusunda ürünlerini gerek standart RAL renklerine gerekse farklı renk ve parlaklık isteklerine göre boyamaktayız.</p> <p>Boyanın profilin yüzeyine yapışmasını ve alt tabakanın korozyon direncini artırabilmek için yaptığımız ön işlem süreçleri sayesinde boyama işleminden geçen profillerin yüzeyi ultraviyole ışınlarına ve ani ısı değişimlerine karşı çok iyi dayanım gösterir</p>	<p>ELECTROSTATIC POWDER PAINTING</p> <p>As per the demands of our customers, we are able to coat products in either standard RAL colours or, depending on preferences, different colours and polishes.</p> <p>The pre-treatments we perform in order to enable the paint to stick to the surface of the profile and to increase the corrosion resistance of the under layer ensure for the profiles that go through colouring processes to have strong resistance against ultraviolet radiation and sudden temperature changes.</p>
<p>KALIPHANE</p> <p>Kalıp sadece profilin çekilmesi için kullanılan bir aparat veya araç değildir. 7.000 çeşidin üstünde ürün yelpazesi ile sektöründeki yerini her geçen gün daha da güçlenmektedir. İyi dizayn edilen bir kalıp profil imalatında şu hususları etkiler</p> <ul style="list-style-type: none"> *Profilde üstün düzey kalitesi sağlanması *Boyutsal toleransların sağlanması *Profillerin her zaman aynı kalitede üretilme birliği *Profilde istenen fiziksel özelliklerin sağlanabilmesi 	<p>DIE SHOP</p> <p>Moulds are not simply apparatuses or tools that are used for formation of profiles. The company has been reinforcing its position in the sector with a product range of over 7 000 varieties. A well-designed mould ensures the following in profile production:</p> <ul style="list-style-type: none"> * Ensuring a high level of quality in profiles * Maintaining dimensional tolerances * Uniformity in the quality of profiles * Achieving the desired physical properties in profiles

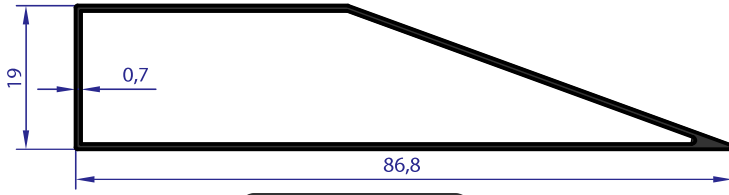
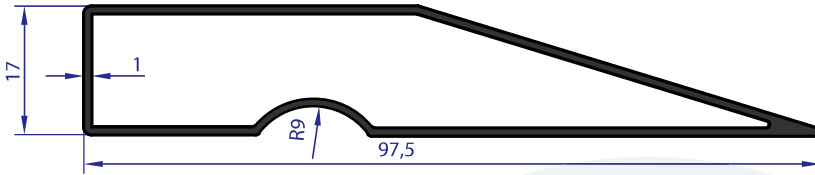
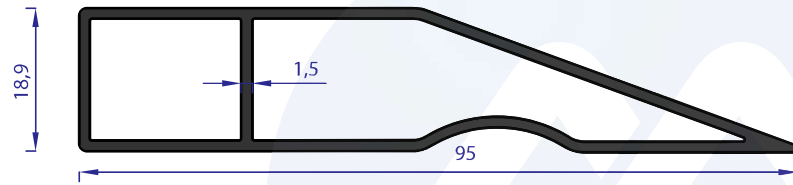
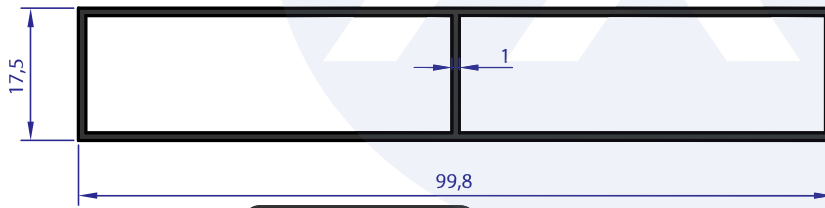
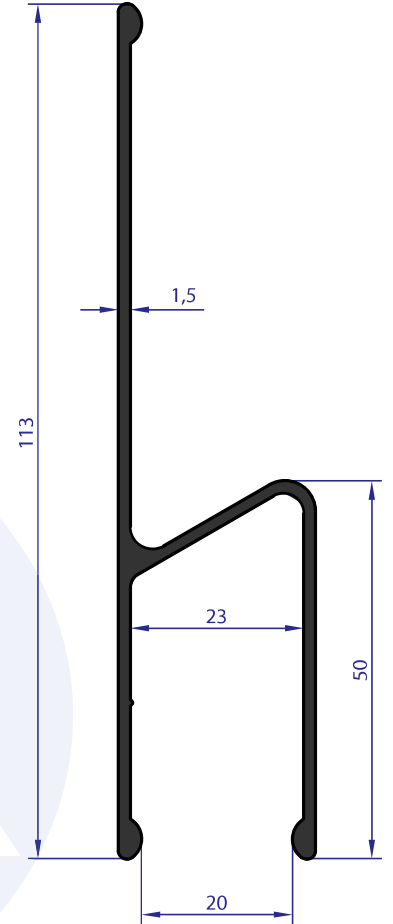
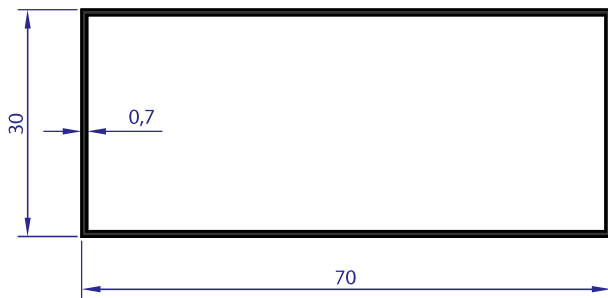
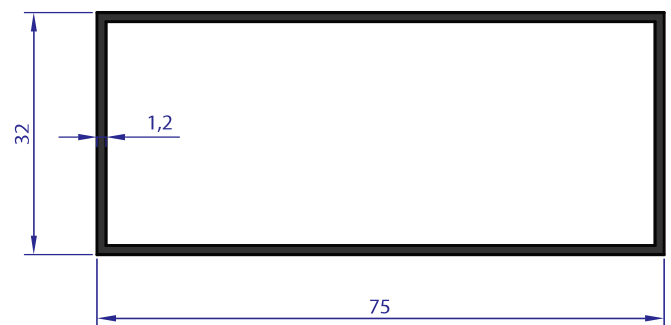
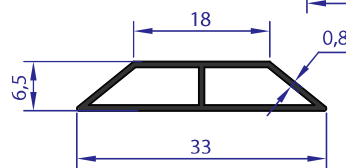

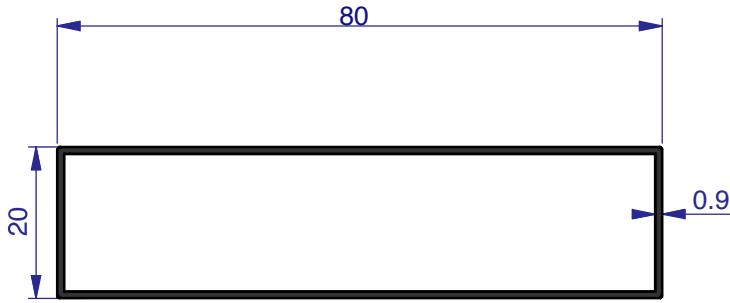
AB 96461
WEIGHT 0.368 Kg/m

AB 95238
WEIGHT 0.578 Kg/m

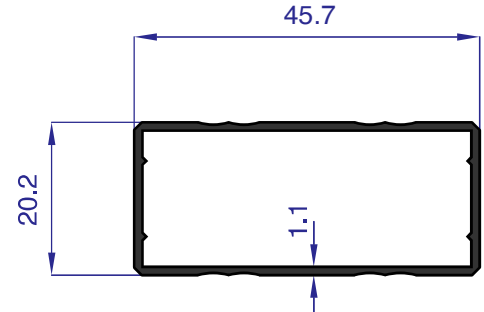
AB 97119
WEIGHT 0.849 Kg/m

AB 95237
WEIGHT 0.666 Kg/m

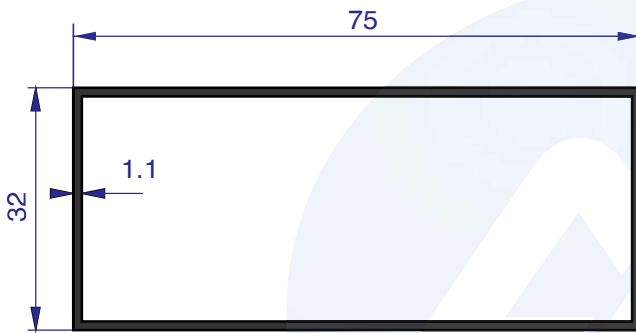
AB 95239
WEIGHT 0.825 Kg/m

AB 96460
WEIGHT 0.374 Kg/m

AB 96029
WEIGHT 0.680 Kg/m

AB 96459
WEIGHT 0.147 Kg/m



AU 7996
WEIGHT 0.478 Kg/m



AU 7991
WEIGHT 0.363 Kg/m



AU 7998
WEIGHT 0.625 Kg/m

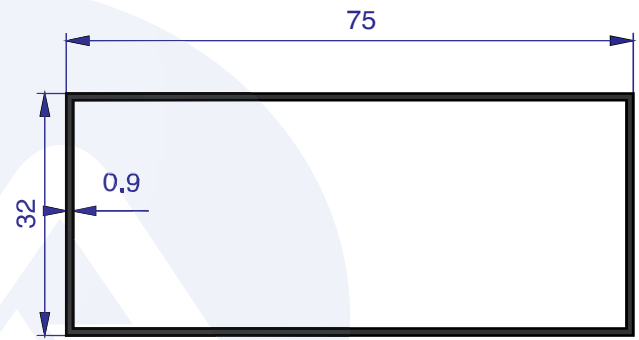

AU 7999
WEIGHT 0.513 Kg/m

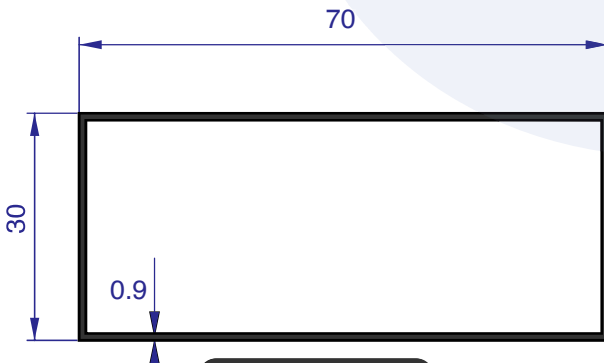

AU 71001
WEIGHT 0.479 Kg/m

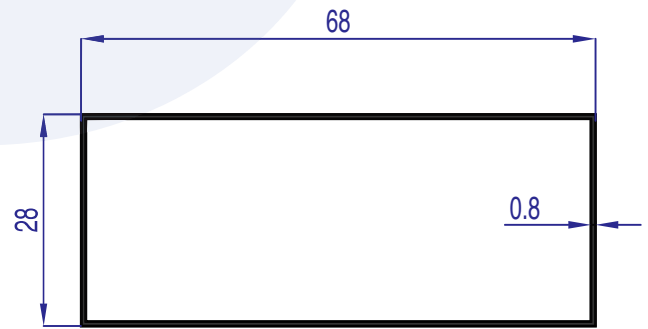

AU 7990
WEIGHT 0.380 Kg/m

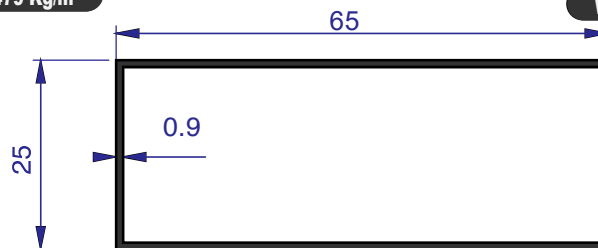

AU 71000
WEIGHT 0.430 Kg/m

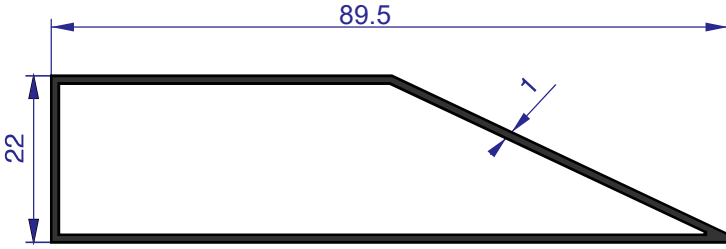

AU 71002
WEIGHT 0.550 Kg/m

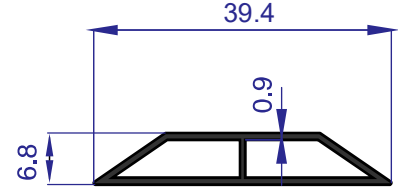

AU 71938
WEIGHT 0.191 Kg/m

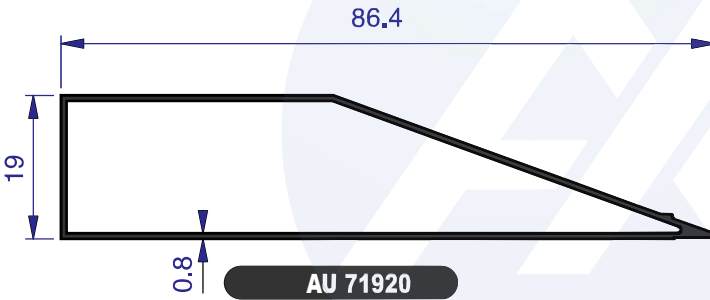

AU 71920
WEIGHT 0.410 Kg/m

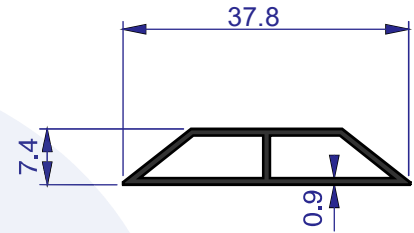

AU 7997
WEIGHT 0.201 Kg/m

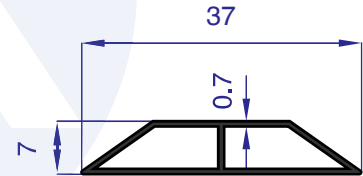

AU 7992
WEIGHT 0.155 Kg/m

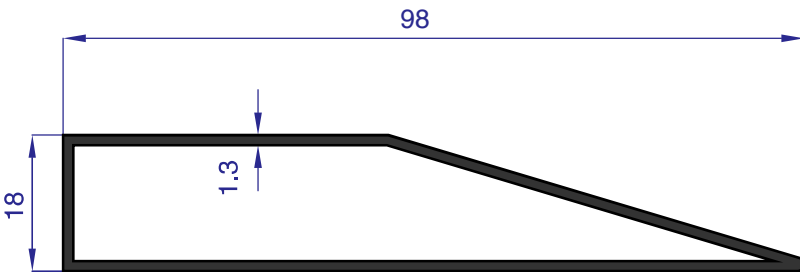

AU 72270
WEIGHT 0.775 Kg/m

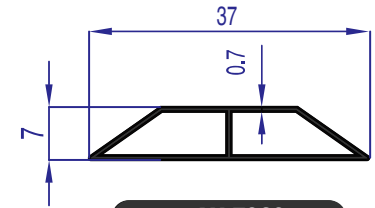

AU 7989
WEIGHT 0.144 Kg/m

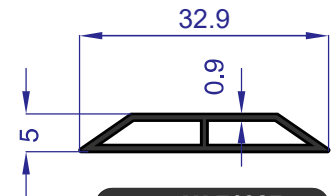

AU 71937
WEIGHT 0.164 Kg/m



ALUMINAKS

ALUMINIUM & ACCESSORIES



ALUMINAKS

ALUMINIUM & ACCESSORIES

Adress: Zafer Mahallesi, Dođan Araslı Blv. No:97/99
NCadde Business Plaza 34510 Esenyurt / İstanbul
Tel : +90 212 999 51 57



WhatsApp : +90 533 671 10 56

www.aluminaks.com.tr / export@aluminaks.com.tr